

LHDS Setup

Revision date: 19/08/20

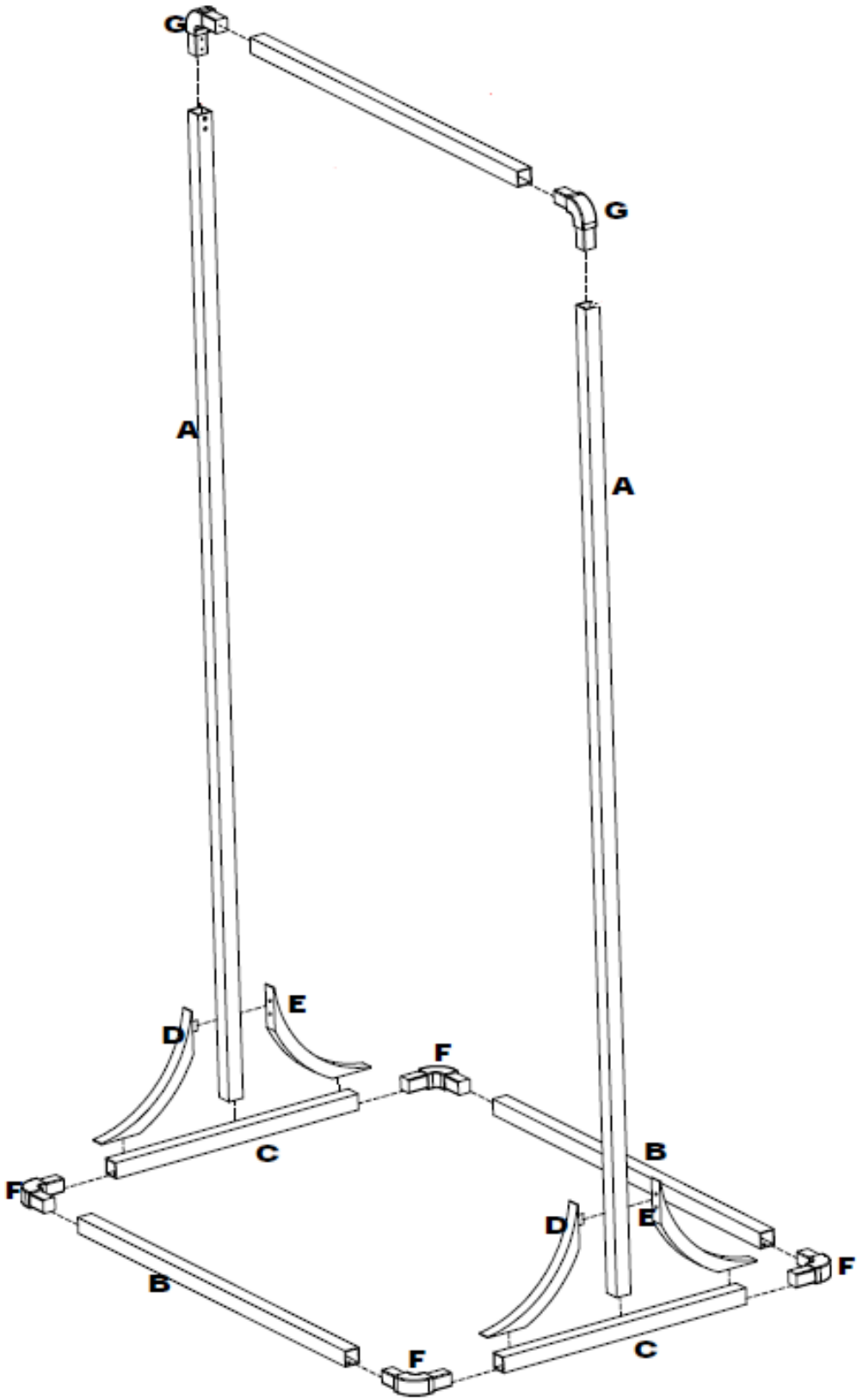



Instructions

 Please read entire instruction sheet before you start.

You will need:

1 x Set of Hexagonal Keys (Allen Keys)

1 x Small Phillips Screwdriver/Drill

Step 1

Begin by assembling the base using Parts “B”, “C” and “F” (see **Figure 1**).

Do not attach one of the “B” Parts at this stage to allow access to any screws that may fall through the base during assembly.

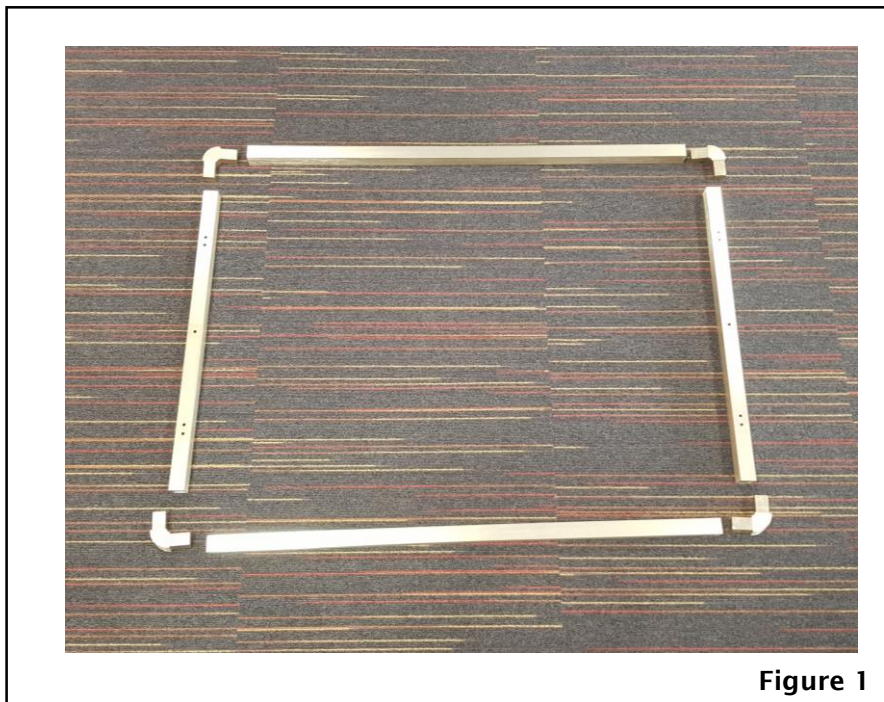

Step 2

There will be 6 large-headed screws in an accessory bag for the screen. Replace 3 of the standard screws on both edges of the screen with these large-headed screws (see **Figure 2**).

Note: This example is for the 55" version of this display. For the 43" version, only 2 screws are needed either side, at the top and bottom.

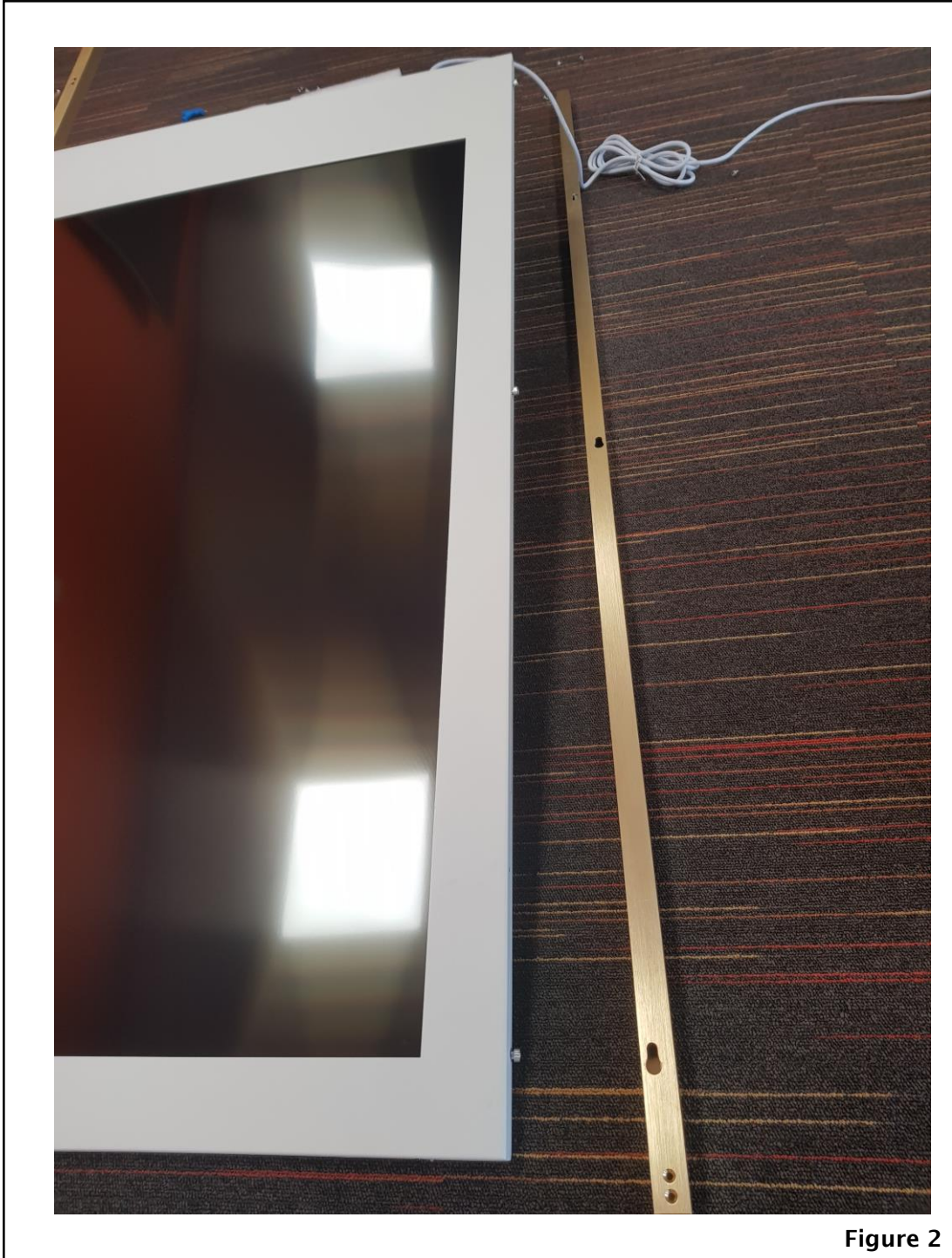

Figure 2

Figure 2 also shows the side of the “A” Parts that will slot onto these screws.

Step 3

Take both of the “A” Parts that will attach to either side of the screen and remove the inner connector rods (see **Figure 3**).

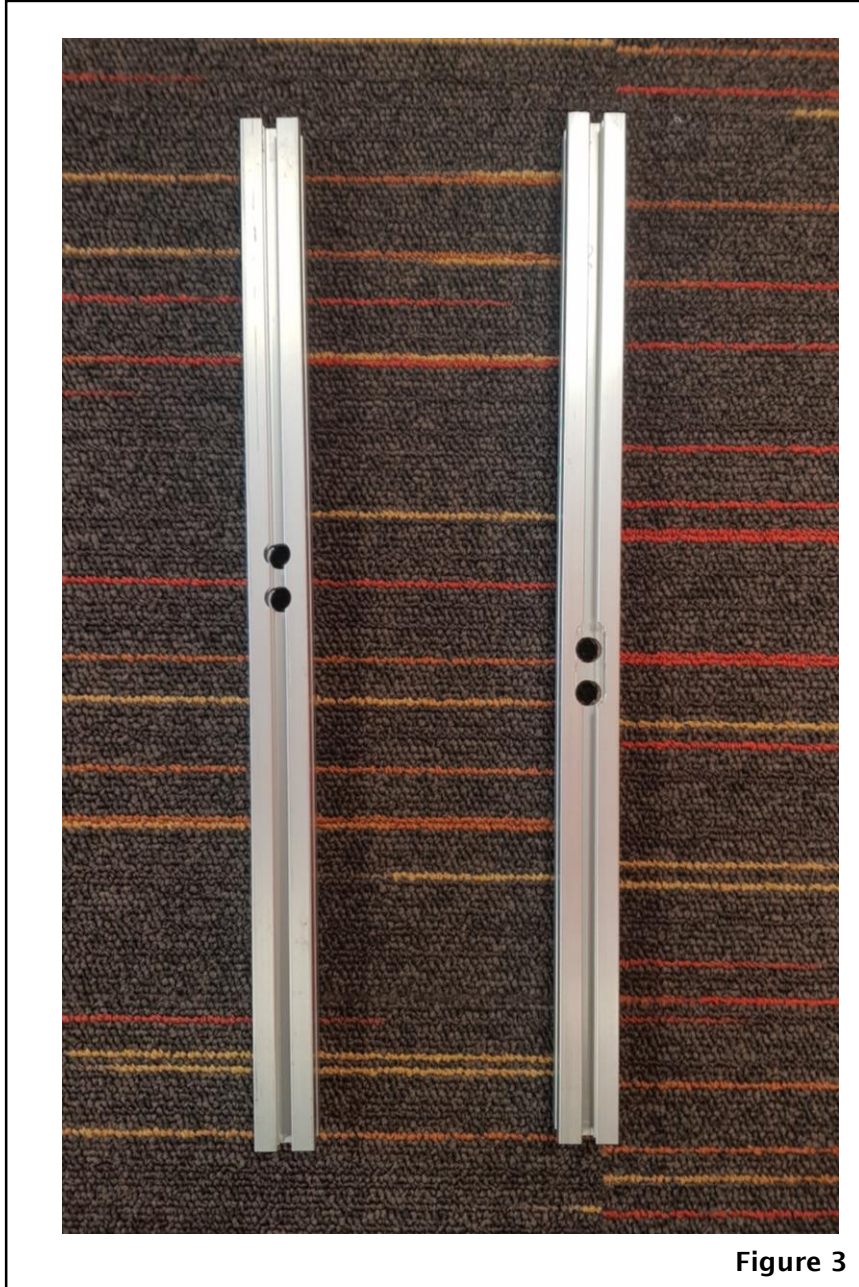

Figure 3

Step 4

Attach the inner rods to the base, in the centre of the “C” Parts (see **Figure 4**).

Note: There will be 2 holes on either side of both of these inner rods. The holes on one side are for standard screws, whereas the holes on the other side will have a larger area around the screw holes for large-headed screws. The standard screw holes should face the “E” Parts and the large-headed screw holes should face the “D” Parts. For this reason, the inner rods need to be attached opposite ways round so that the security poles (Parts “D” and “E”) can be attached correctly.

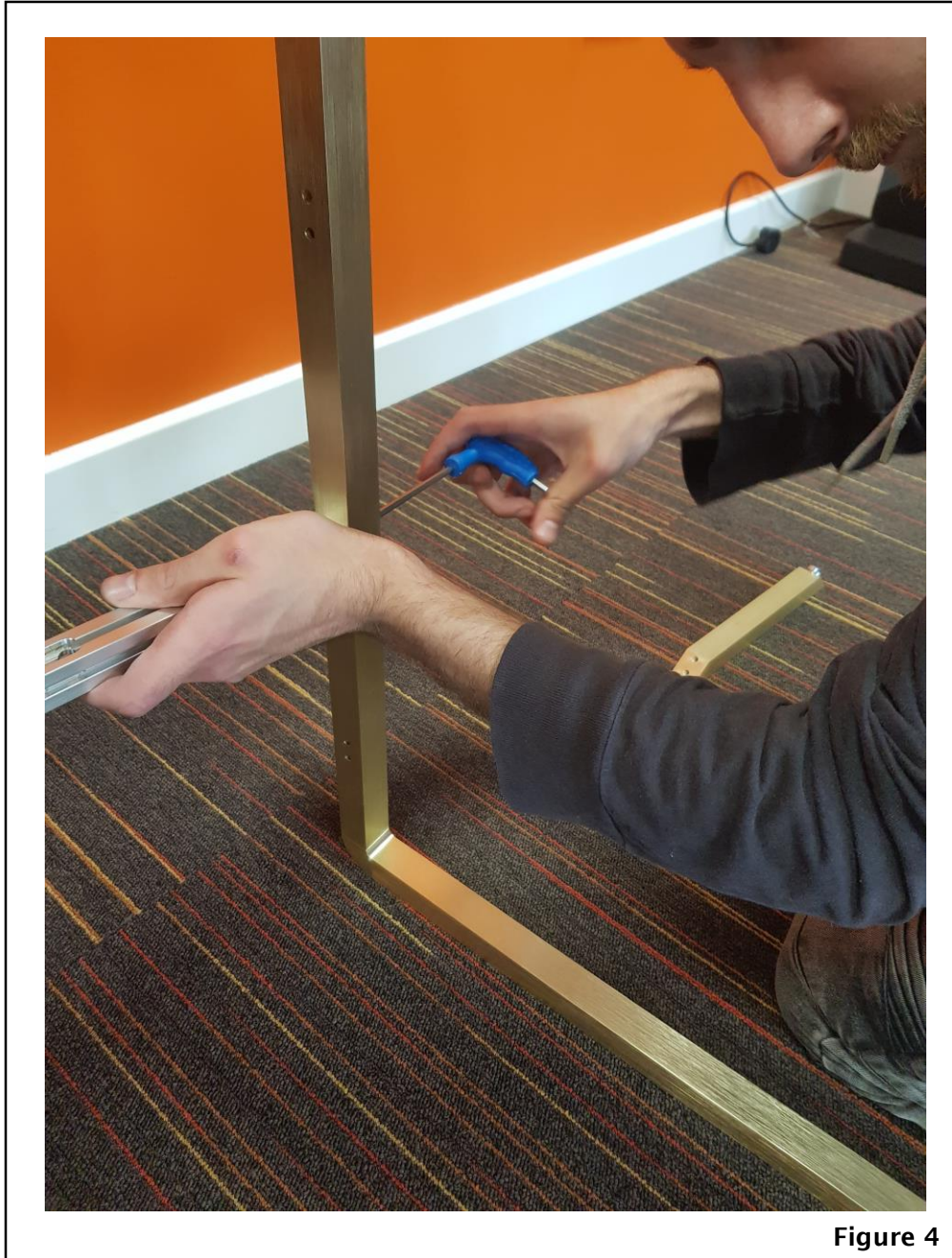

Figure 4

Step 5

Attach the inner rods, which should be attached to the base, to the side poles ("A" Parts), which should be attached to either side of the screen (see Figure 5).

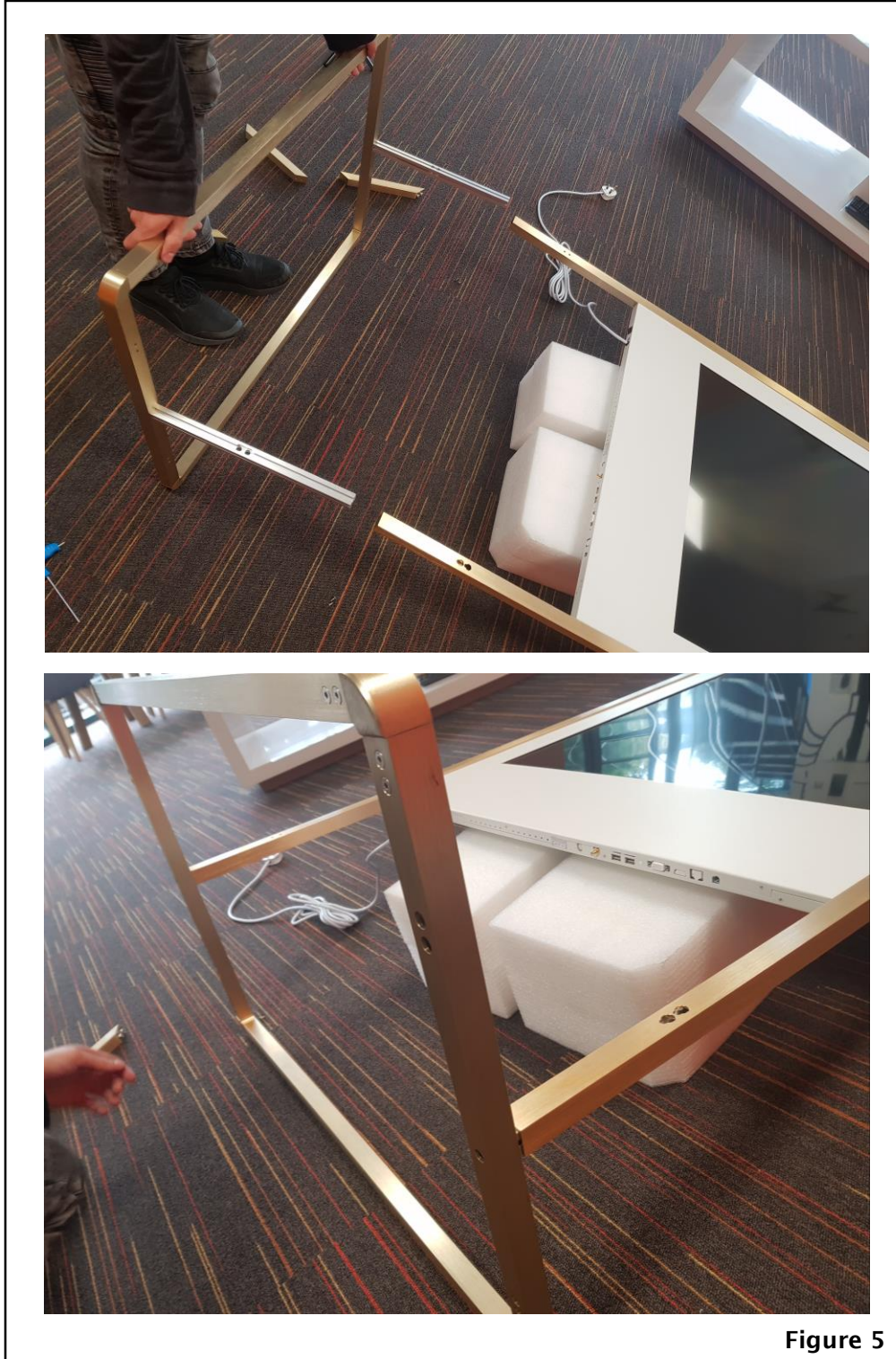

Figure 5

Step 6

Secure the side poles (“A” Parts) to the base properly by attaching the security poles (Parts “D” and “E”; see **Figure 6**). The “E” Parts will be secured with standard screws only (see **Figure 7**). The “D” Parts will slot onto the “A” Parts with large-headed screws (see **Figure 8**) and then be screwed onto the base (see **Figure 9**).

Note: Start with the “E” Parts, as the “D” Parts will cover the screw holes.



Figure 6

“E” Parts (left) and “D” Parts (right)



Figure 7
Screwing "E" Parts onto "A" Parts and base



Figure 8
Holes in "A" Parts for slotting on
large-headed screws of "D" Parts



Figure 9
Screwing "D" Parts onto base



Figure 10
Base securely attached to side poles using security poles

Step 7

When the base is secured to the side poles (“A” Parts), the final “B” Part can now be attached.

Step 8

To assemble the top of the stand, begin by attaching 3 pieces: the final “B” Part, and the 2 “G” Parts. The 2 screw holes on either end of the final “B” Part need to be facing upwards, and the “G” Parts need to be pointing downwards (see **Figure 11**).



Figure 11

Step 9

Slot the assembled “B” and “G” Parts onto the top of the “A” Parts, and then carefully lift this frame to sit on the base. Finally, secure the “G” Parts to the side poles (“A” Parts) using the screws provided (see **Figure 12**).

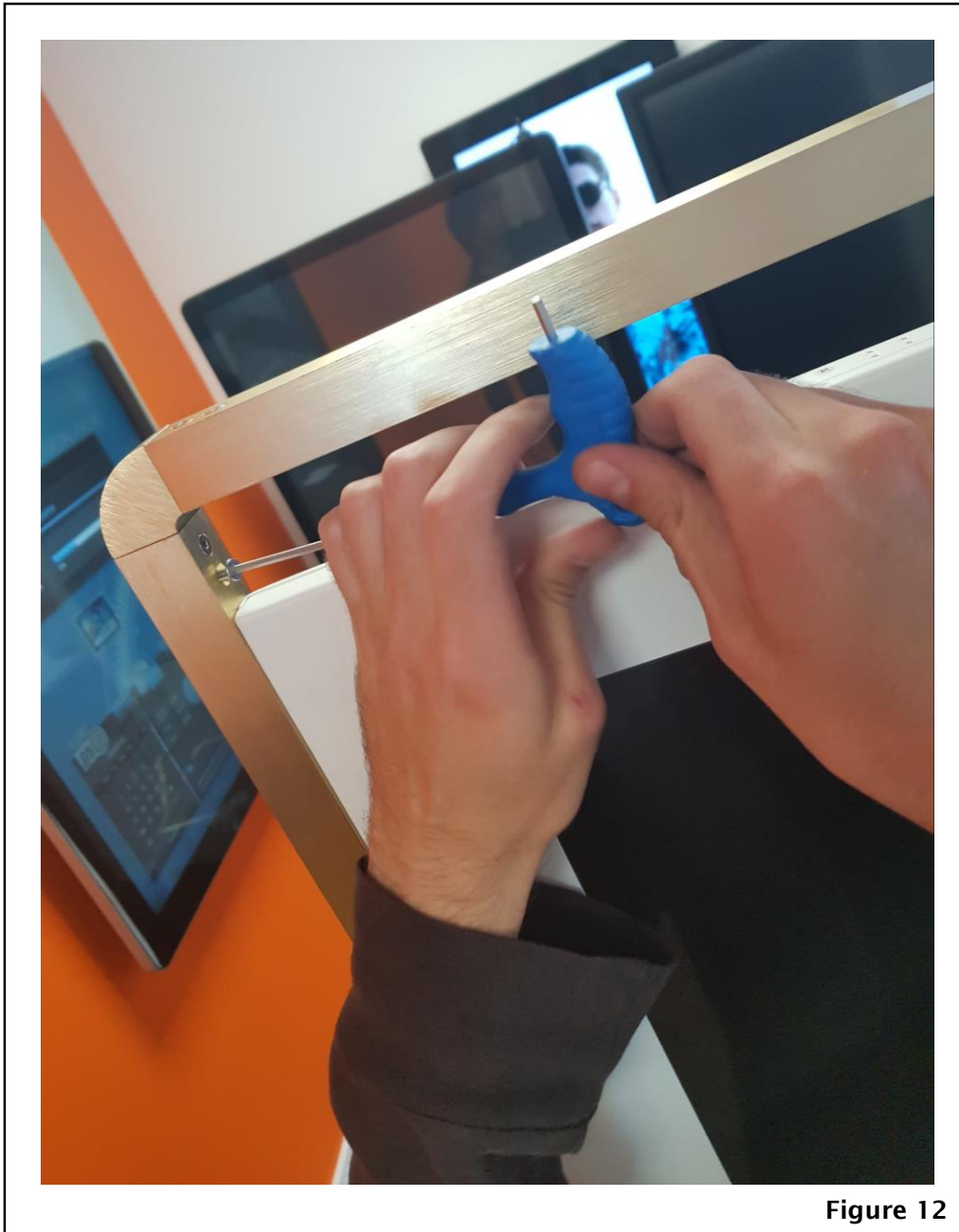

Figure 12